

7 String - C Major Scale

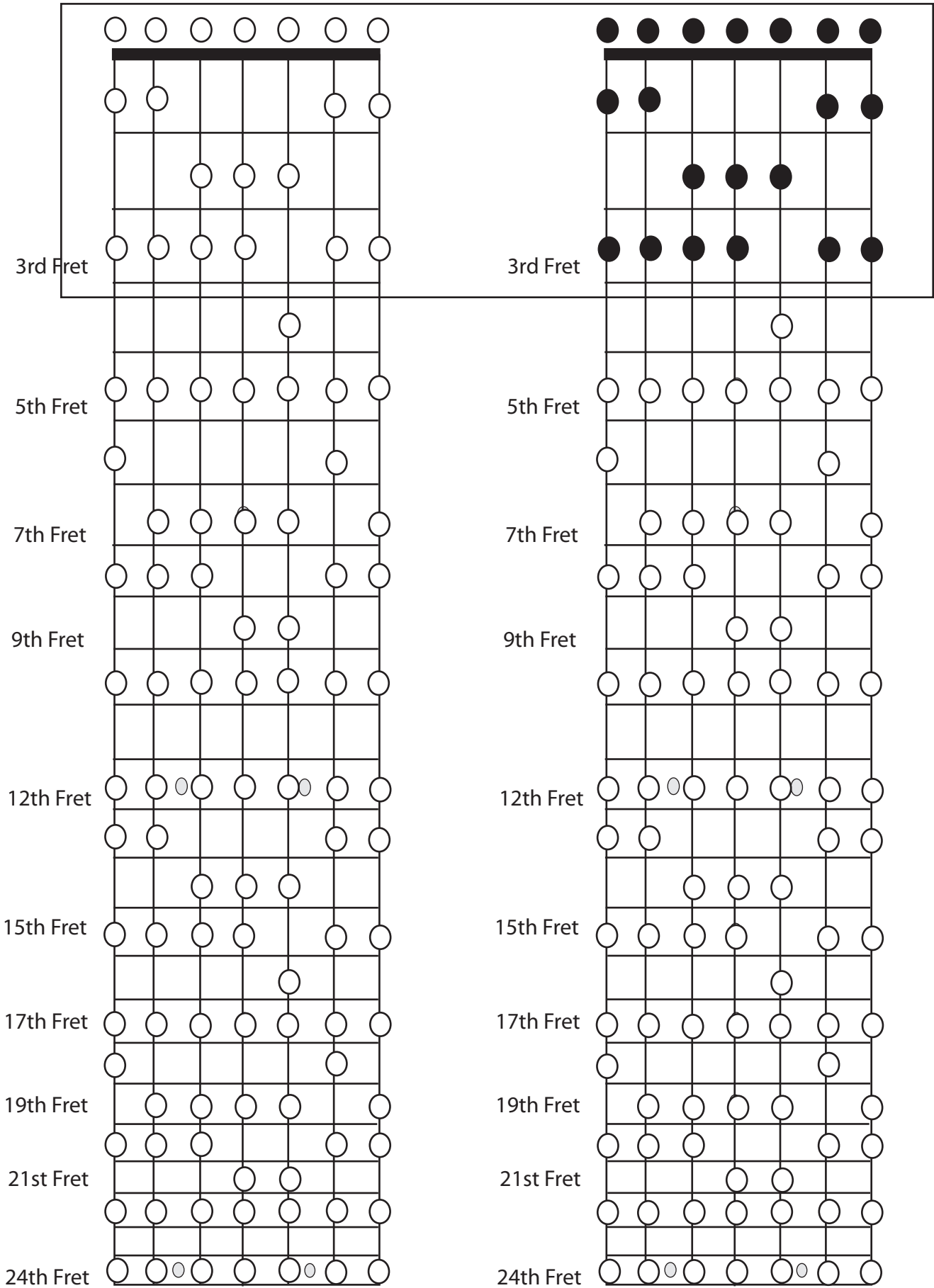

7 String - C Major Scale

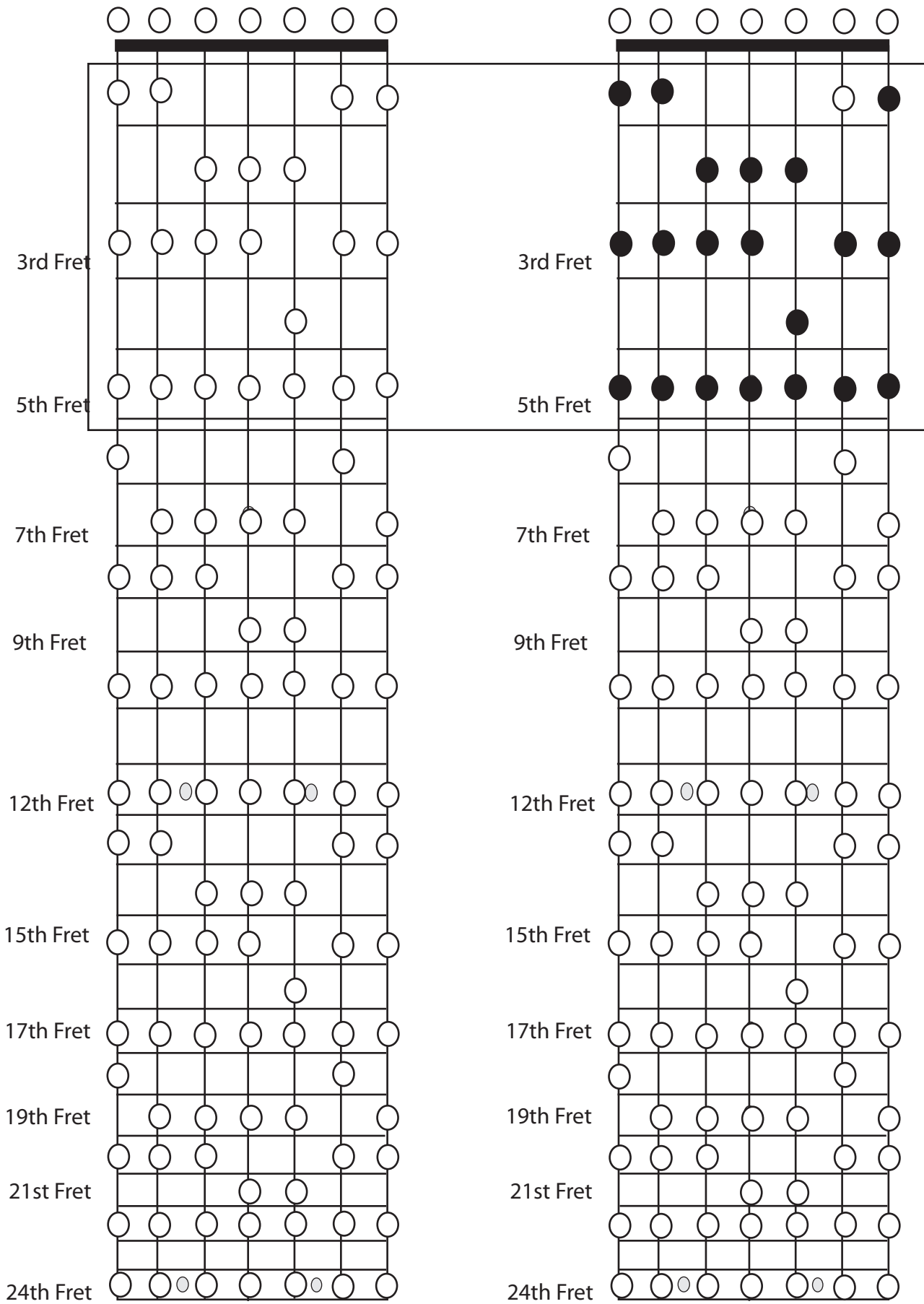

7 String - C Major Scale

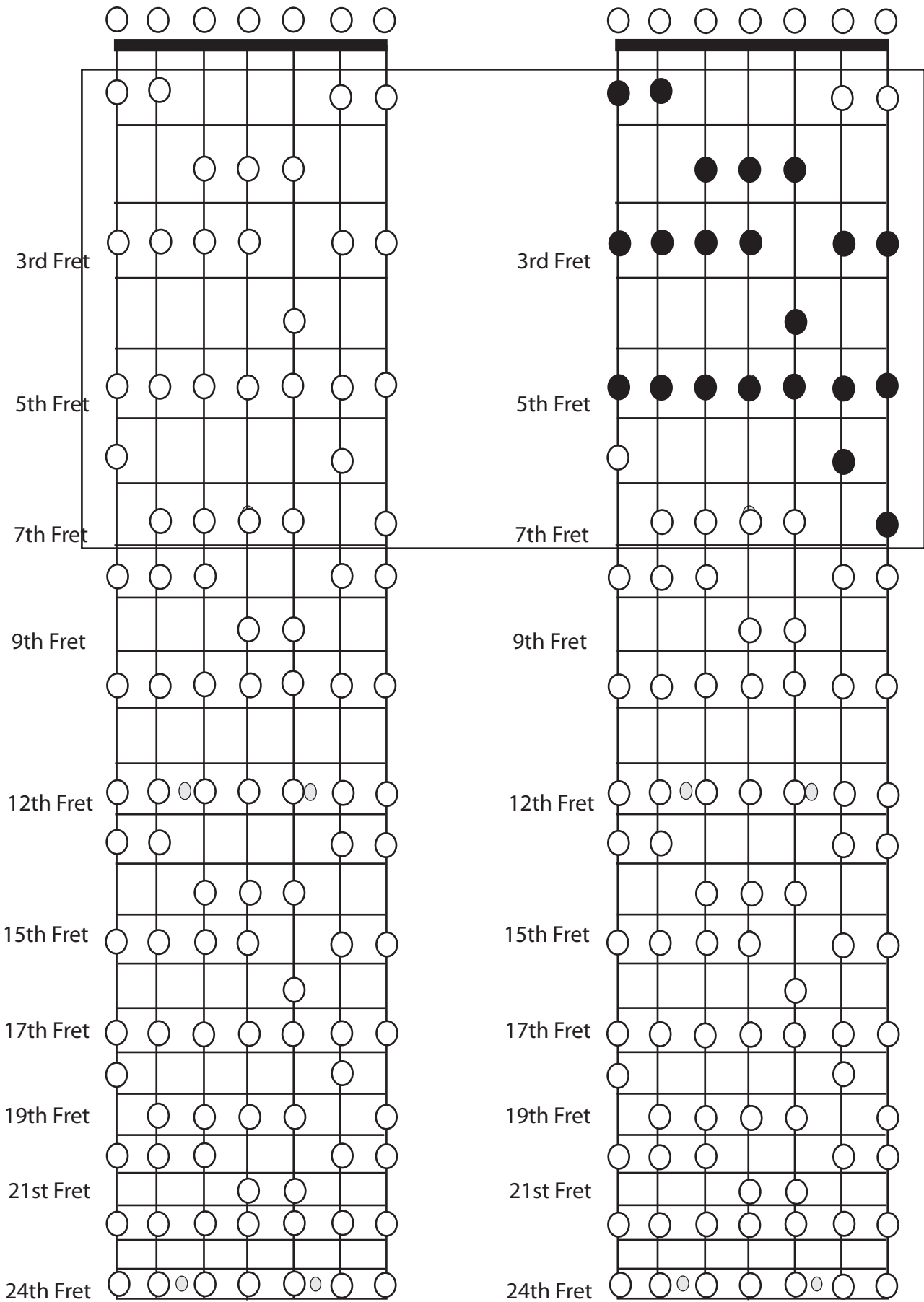

7 String - C Major Scale

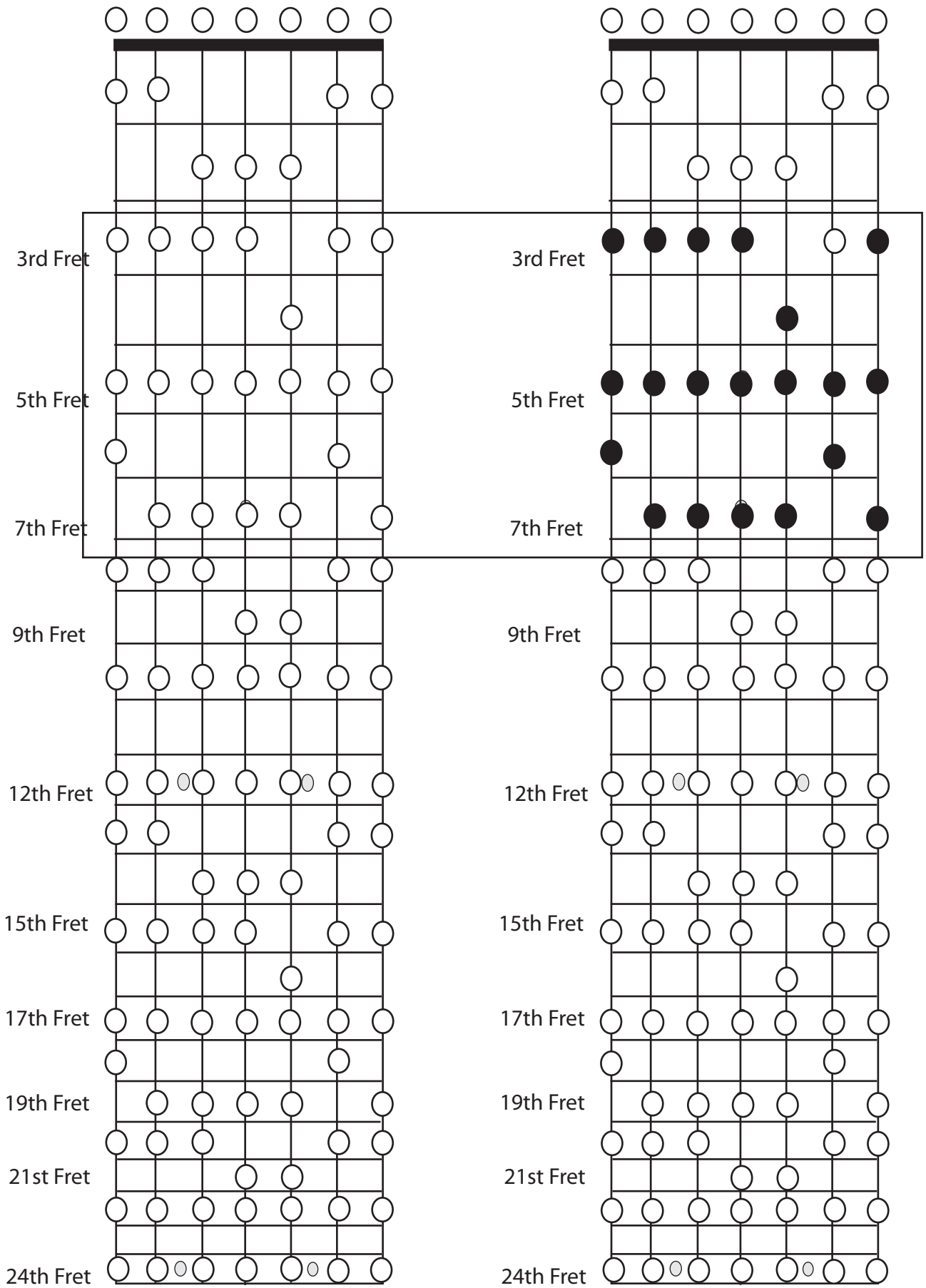

7 String - C Major Scale

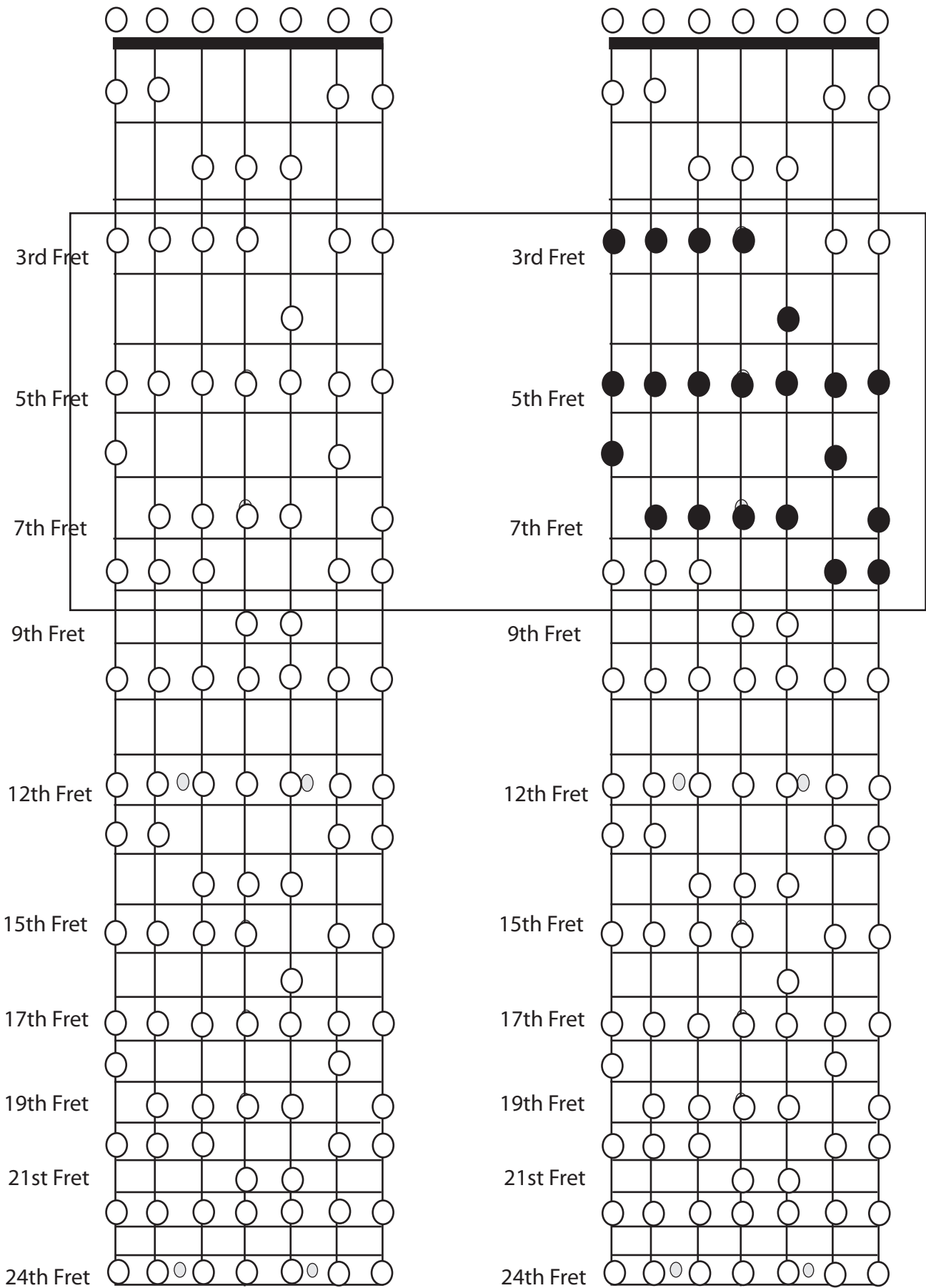

7 String - C Major Scale

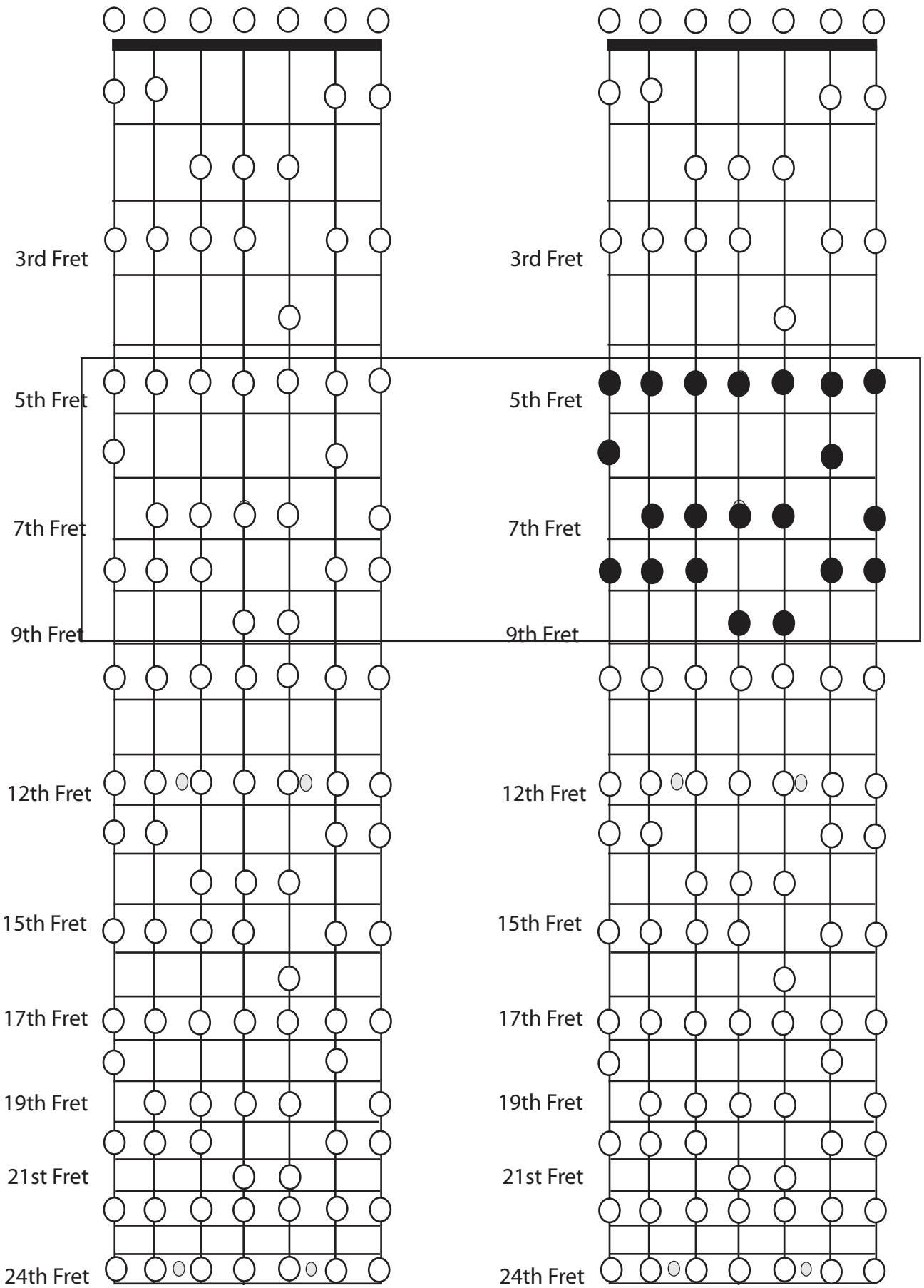

7 String - C Major Scale

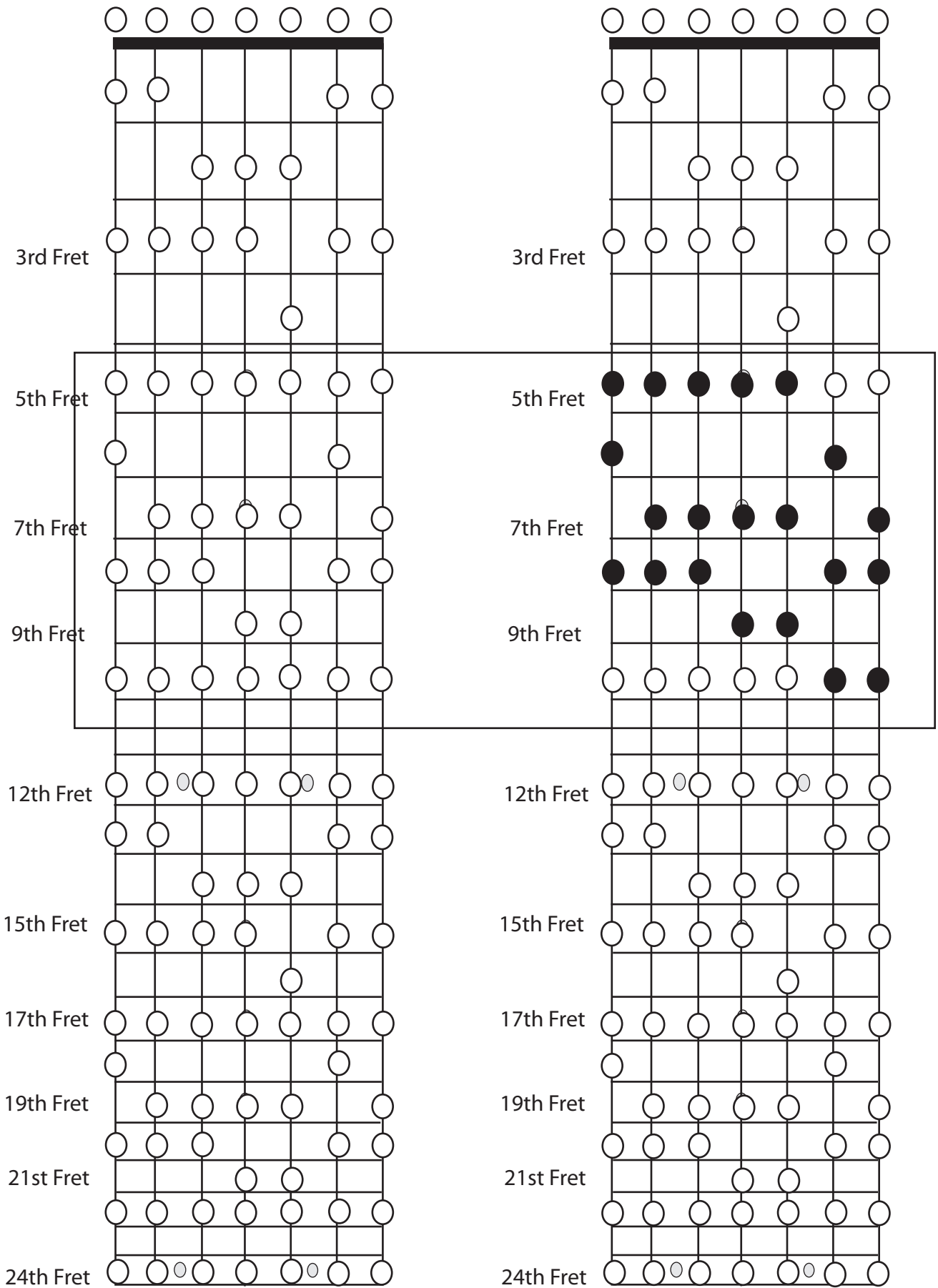

7 String - C Major Scale

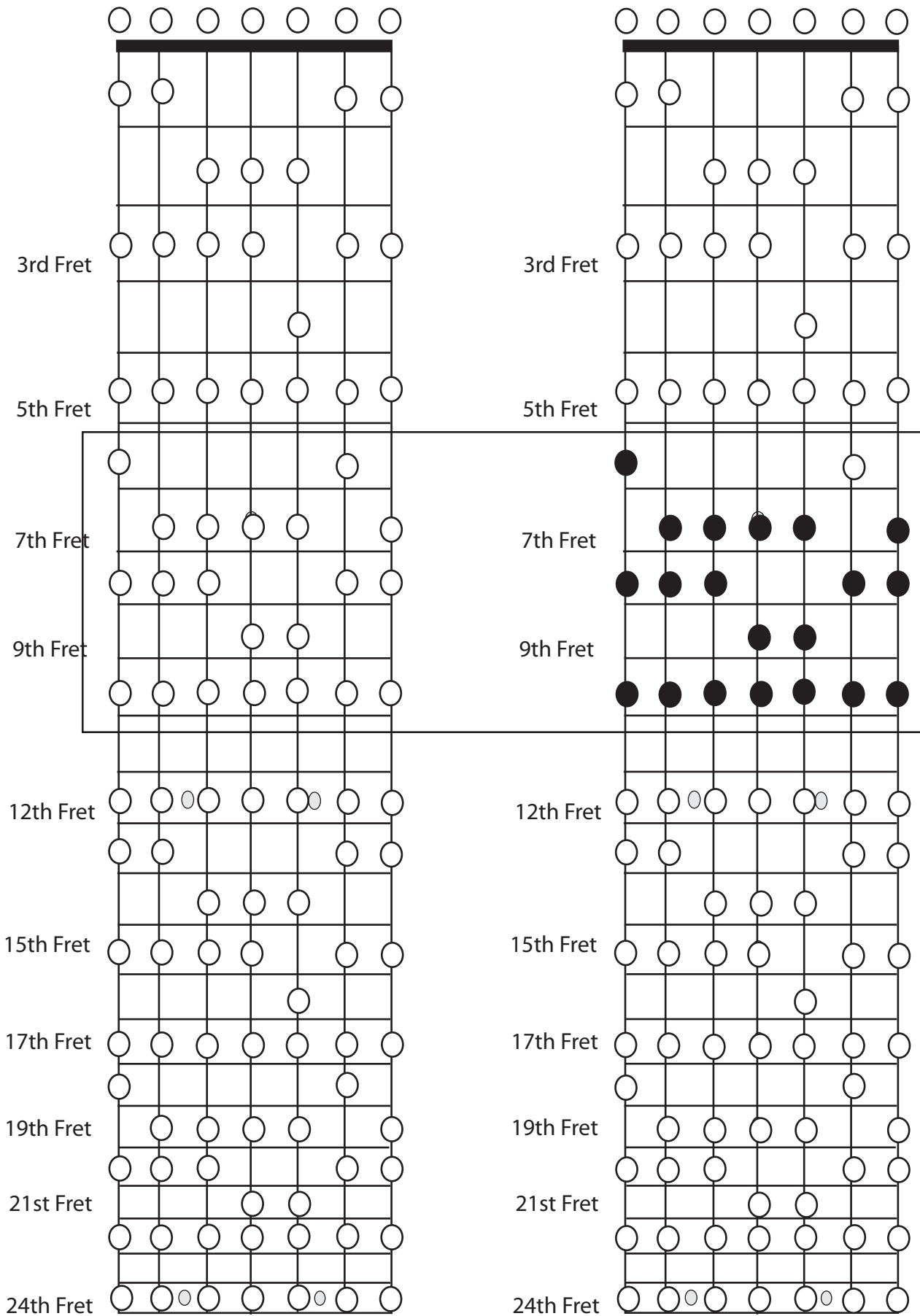

7 String - C Major Scale

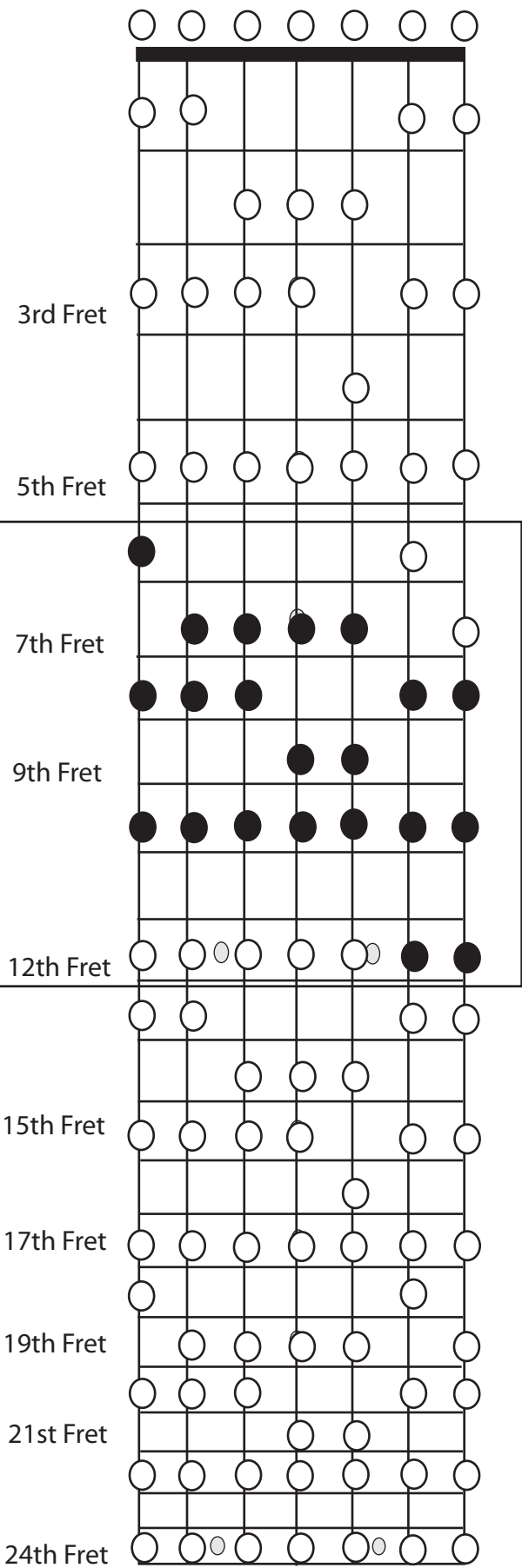
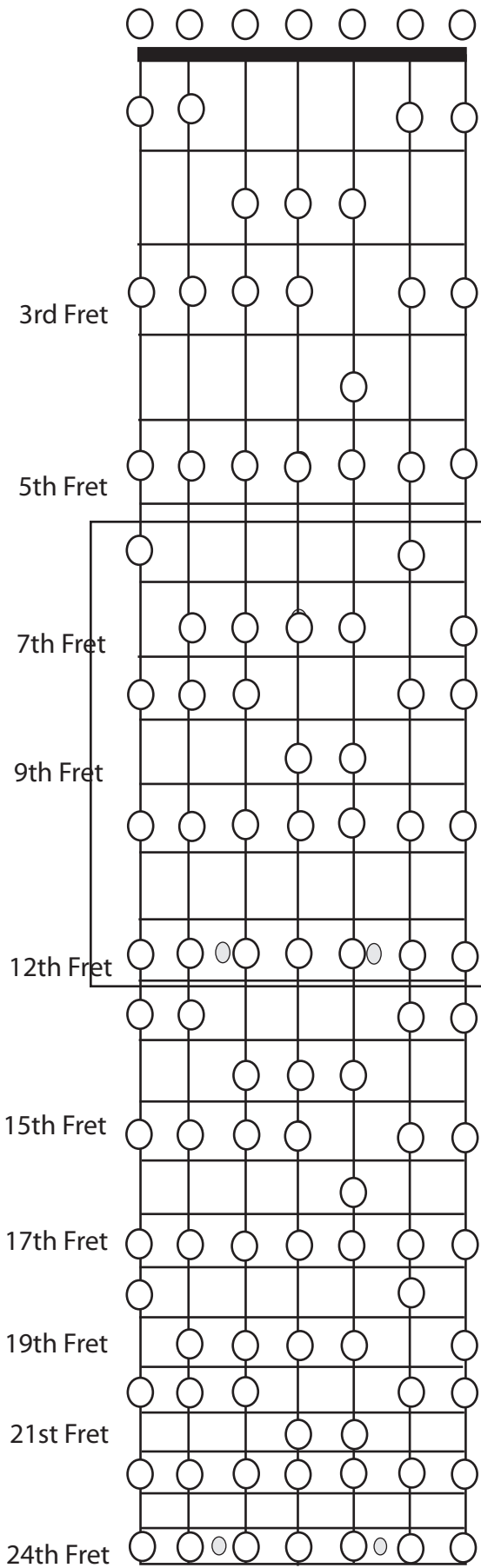

7 String - C Major Scale

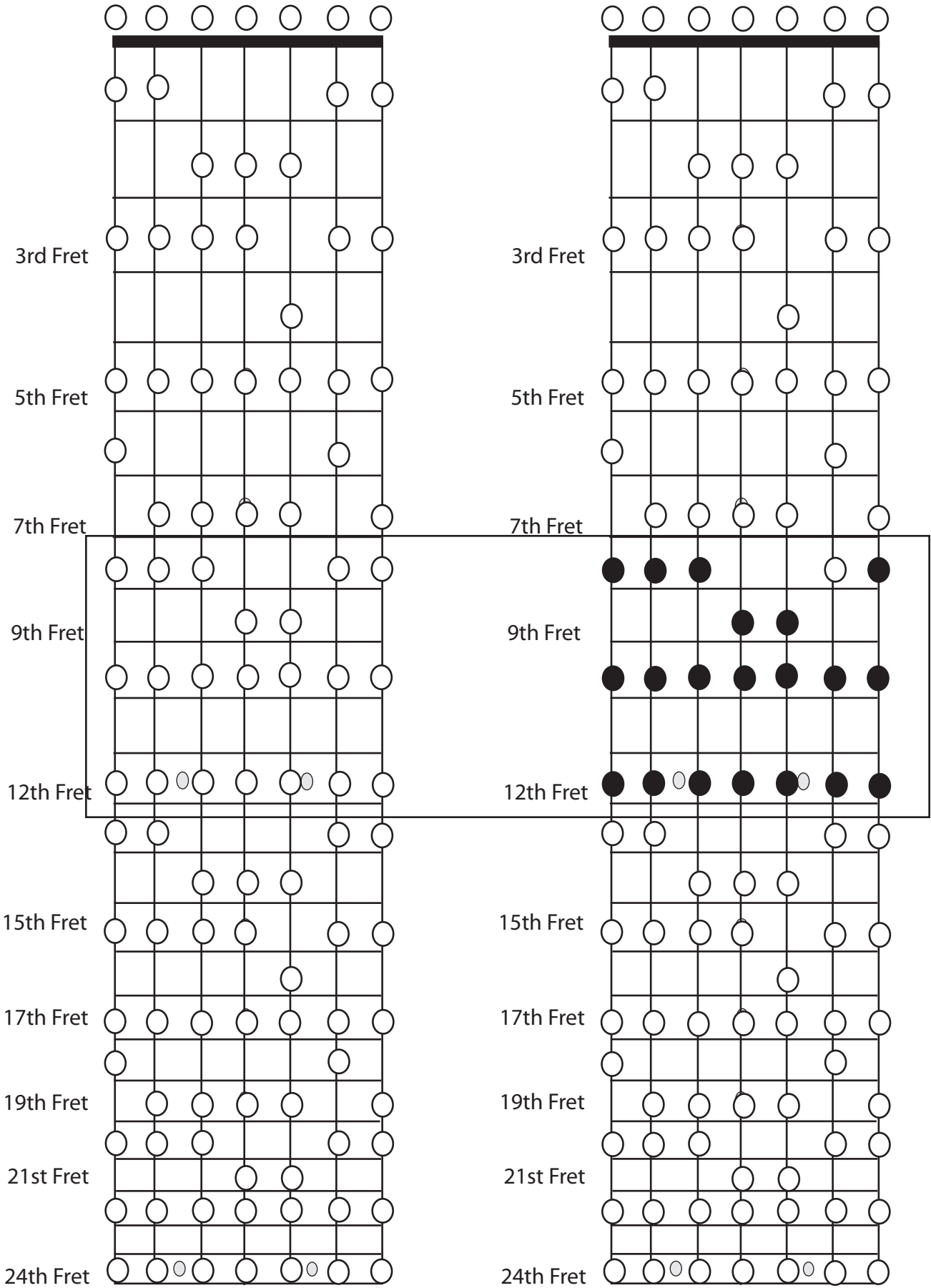

7 String - C Major Scale

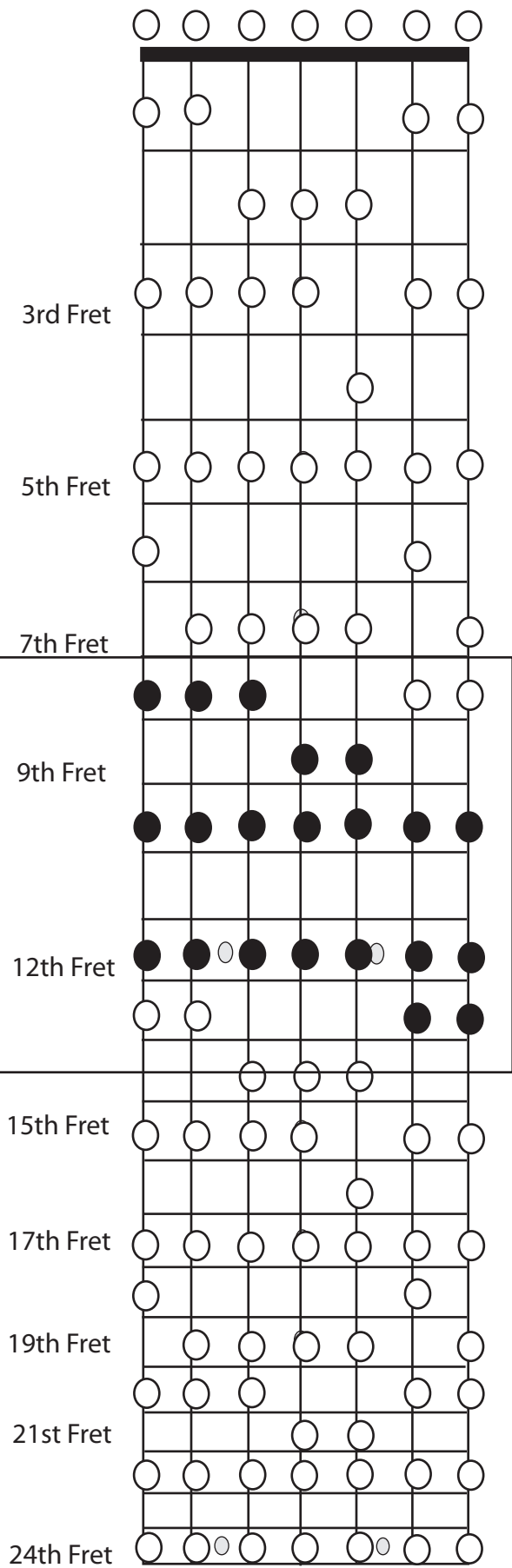
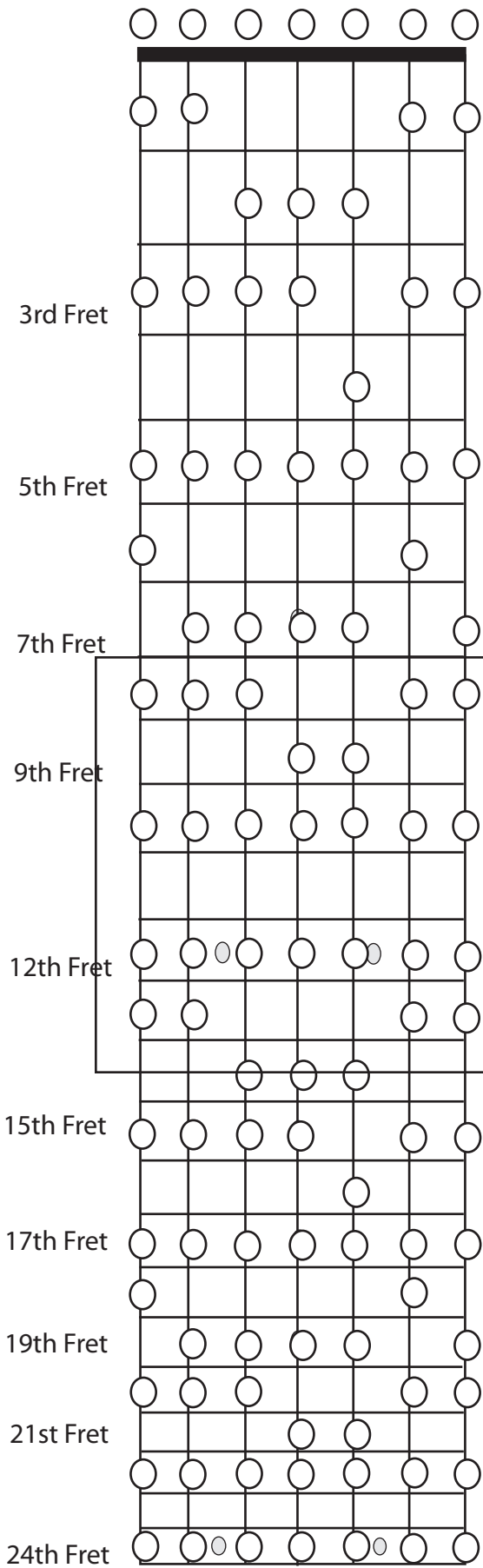

7 String - C Major Scale

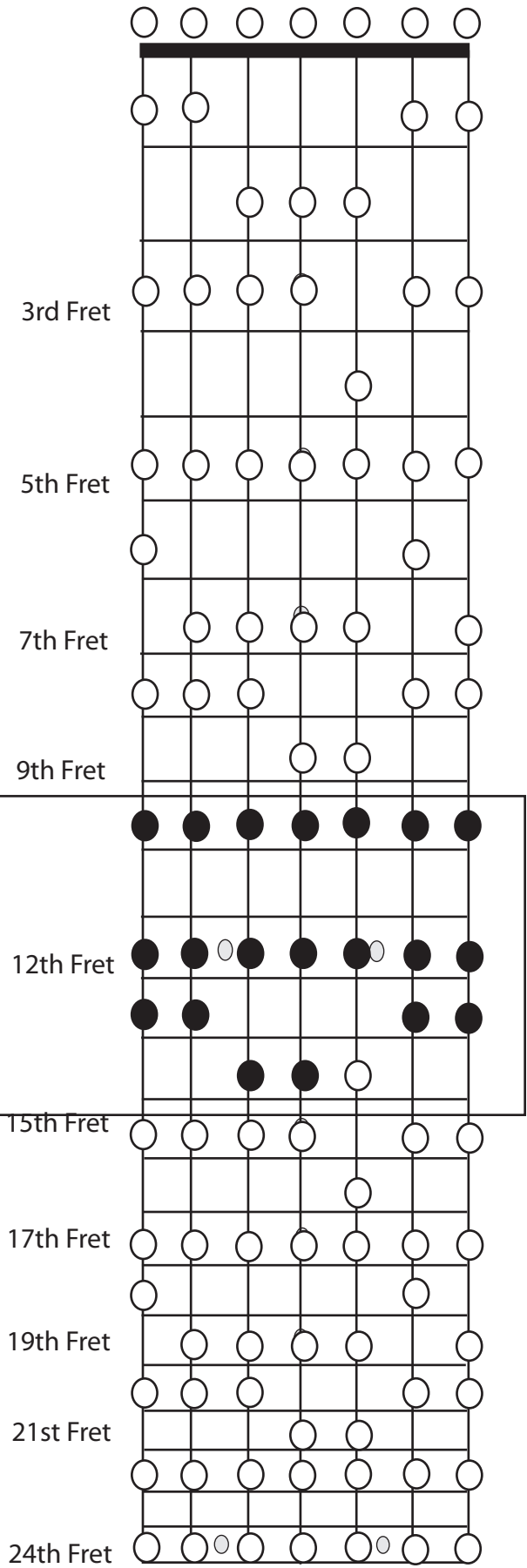
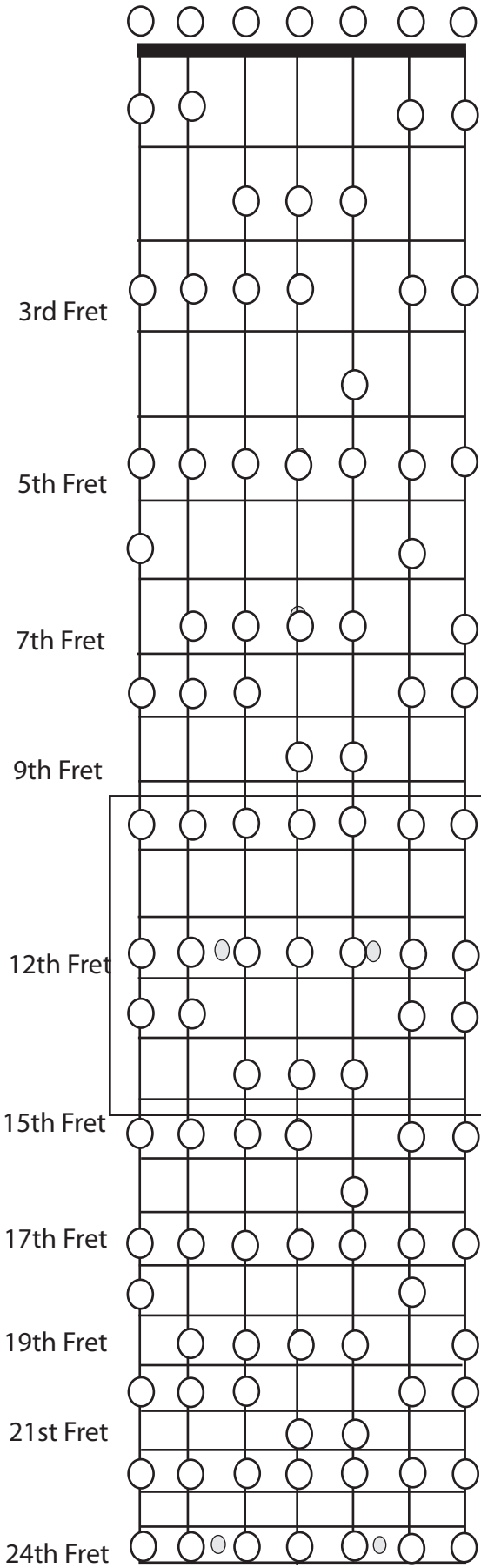

7 String - C Major Scale

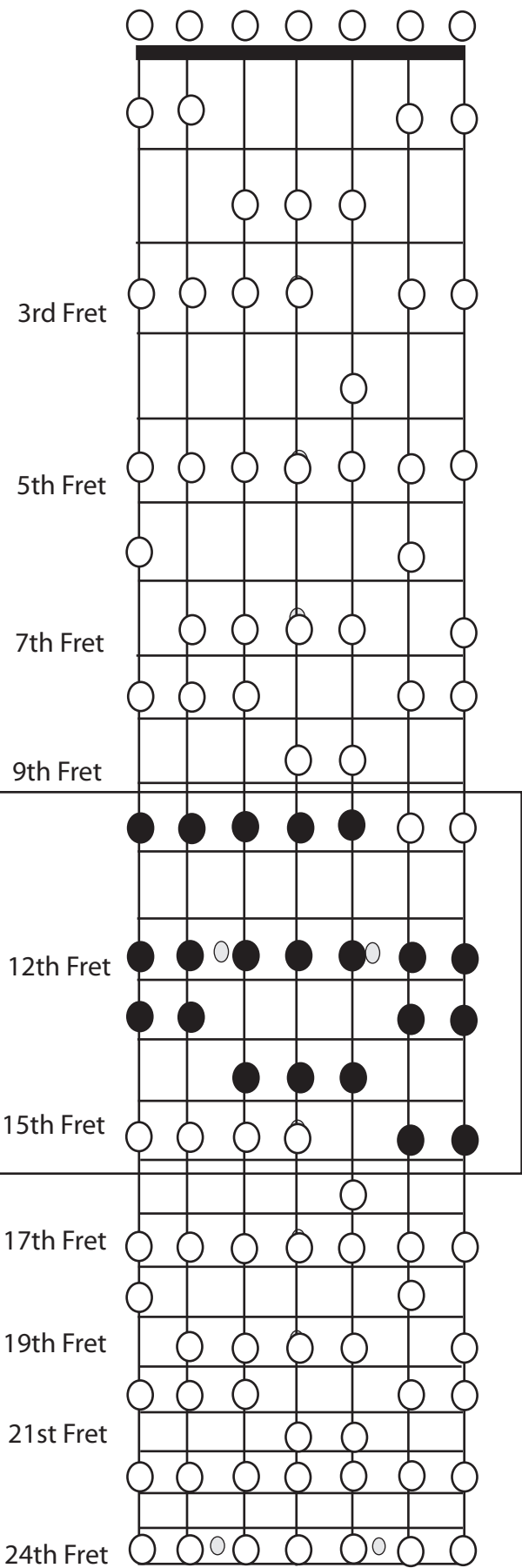
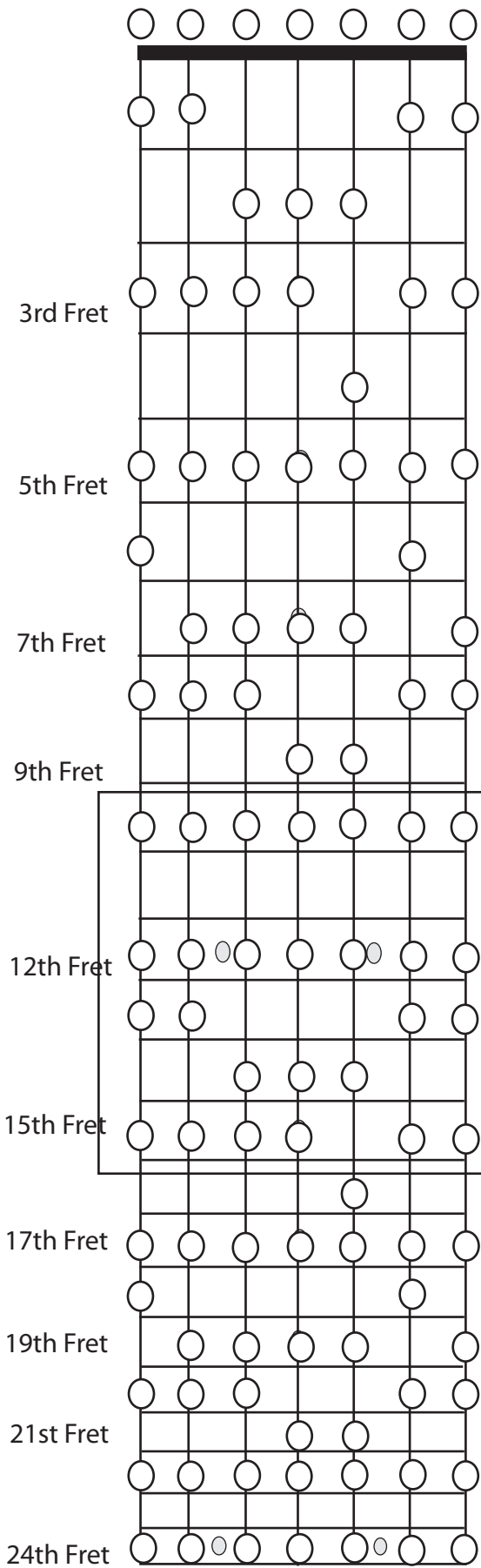

7 String - C Major Scale

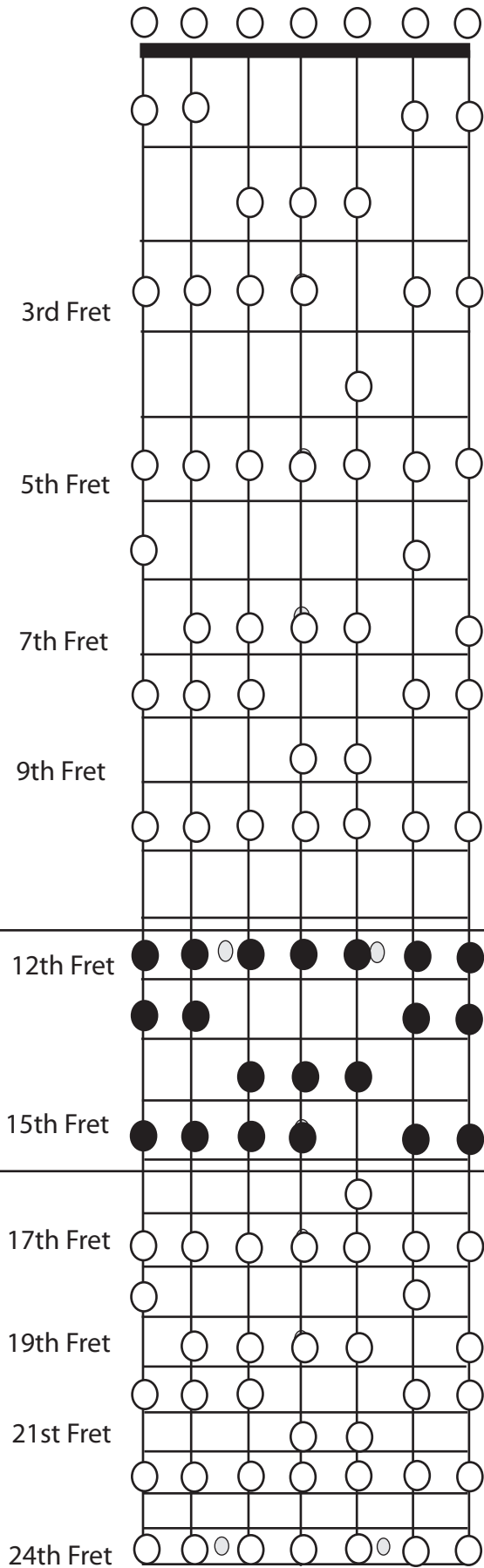
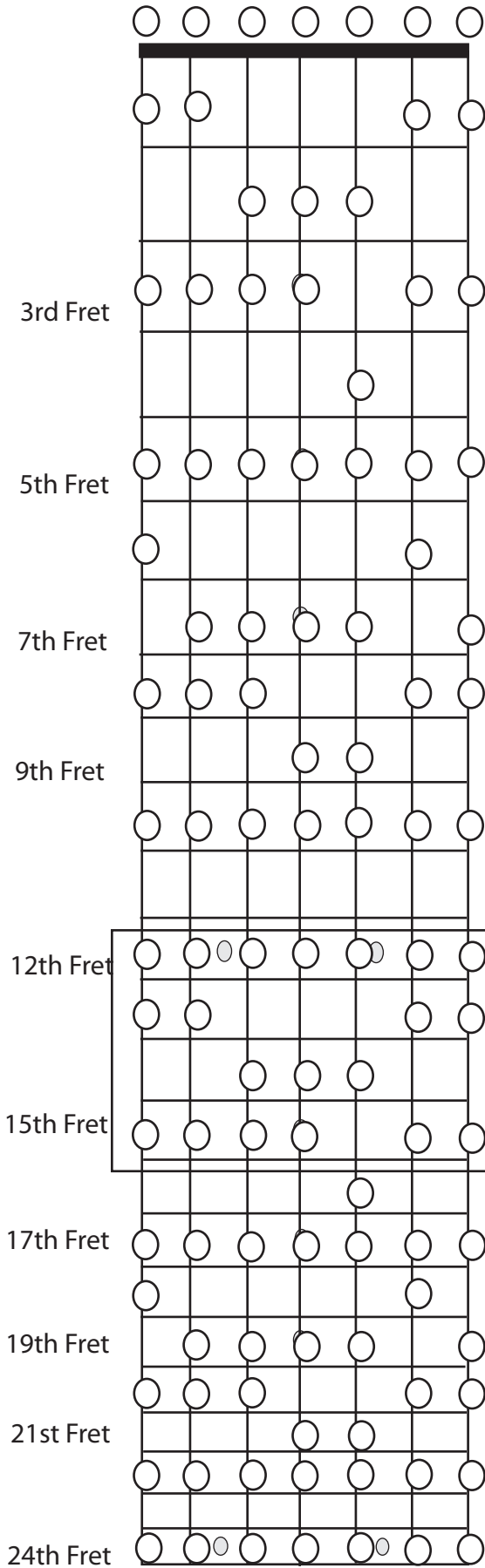

7 String - C Major Scale

